

## UC9500 High Density MTP®/MPO Module



(Only for reference)

- Recommended for method/polarity “B” 10G MPO channel using Type “B” MPO Trunk Cable to achieve simple migration to method/polarity “B” 40/100G MPO channel
- Available in Duplex LC
- Available in G657A, OM3 and OM4
- Utilises bend-insensitive fibre
- Plug & Play Installation
- Maximum Packing Density
- Type “P” is Draka UC defacto, Type A and B are available.
- 100% Tested
- Utilised with UC9500 1U Distribution Panel, 4-Slot, Empty

### Standards

ISO/IEC 11801, ANSI/TIA-568-C.3, IEC 61754-20, IEC 61754-7, RoHS Compliant

### General Specifications

| Item                           | Description   |      |
|--------------------------------|---|------|
| Module Housing Material        | Aluminum alloy, Thickness 0.8mm                                   |      |
| Module House Surface Finish    | Watermark painted   |      |
| Module Housing Colour          | BLACK   |      |
| Front Adaptor                  | Duplex LC with dust cap   |      |
| Rear Adaptor                   | MTP®/MPO with dust cap  |      |
| LC Adaptor Colours             | OM3 AQUA ; OM4 VIOLET ; SM BLUE                                   |      |
| Assemblies                     | Pre_installed male MTP®/MPO to fanout LC assemblies inside module |      |
| Performance                    | Insert Loss(MTP®/MPO+LC)      Return Loss(per fiber)              |      |
| SM                             | 0.75dB(standard)  | 55dB |
|                                | 0.5dB(Low Loss)   |      |
| MM                             | 0.5dB(standard),  | 26dB |
|                                | 0.35dB(Low Loss)  |      |
| Durability                     | 500 mating  |      |
| Installation temperature       | 0°C to +60°C  |      |
| Operating Temperature          | -20°C to +70°C  |      |
| Storage & Shipping Temperature | -40°C to +75°C  |      |

## Construction

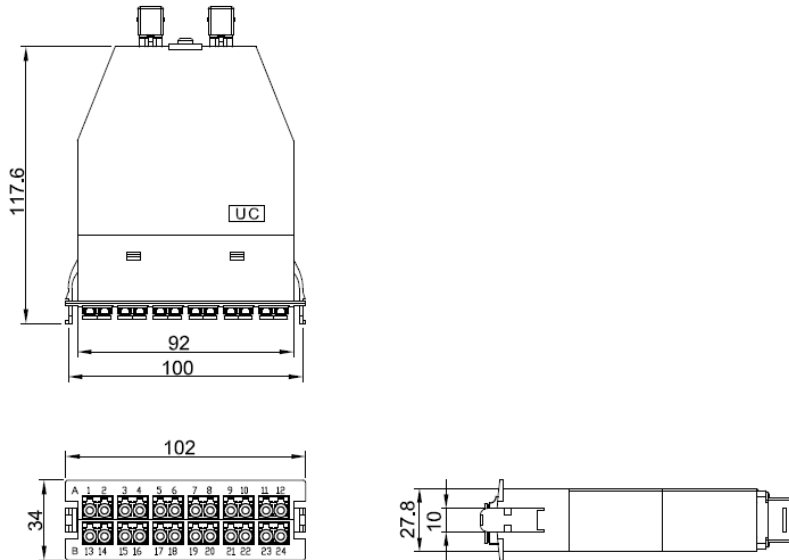

## Ordering Information

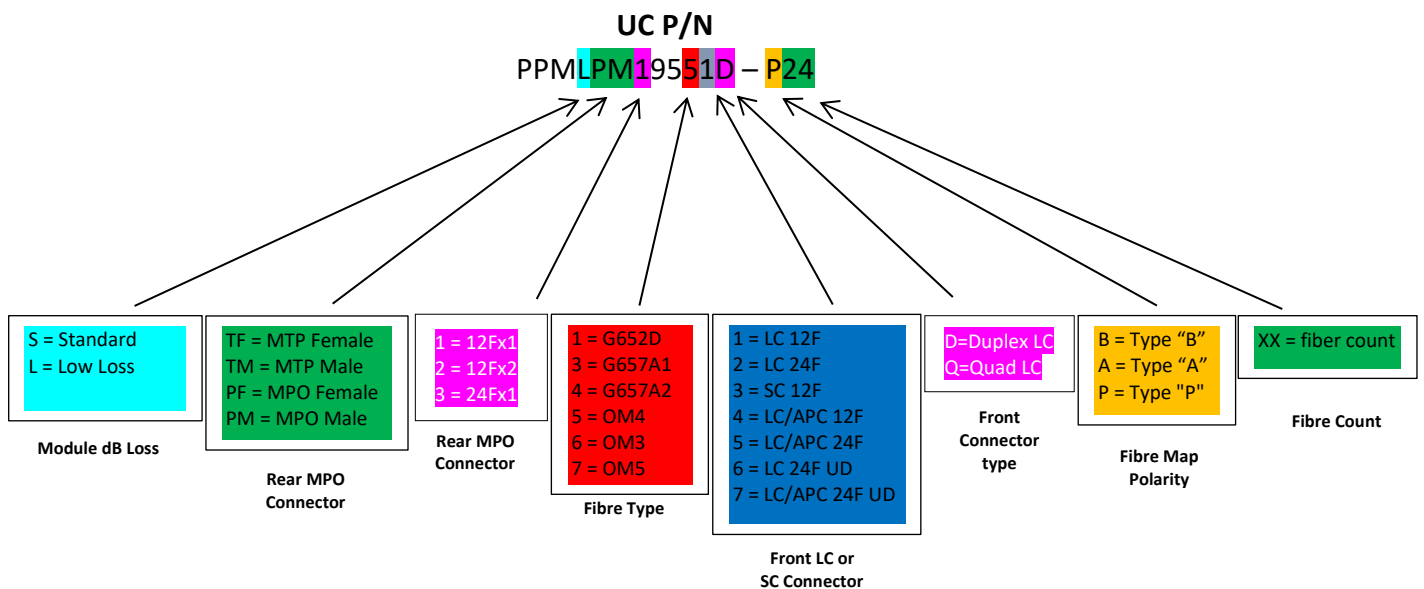

Remark: MPO/MTP-APC for SM, MPO/MTP-UPC for MM, LC-UPC as standard.  
UD: LC Key up for first row, Key down for second row.

## Mapping for MM:

### 10G MPO Channel **Type P MM**

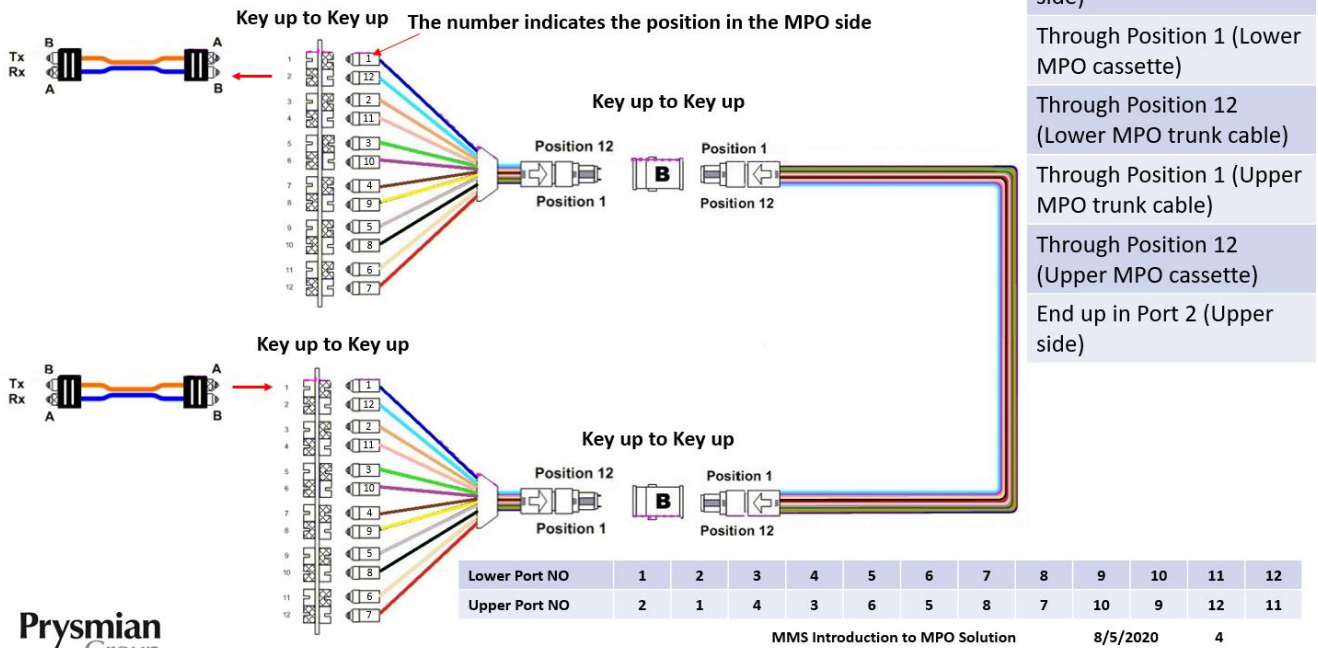

## Mapping for SM:

### 10G MPO Channel **Type P SM Key Up**

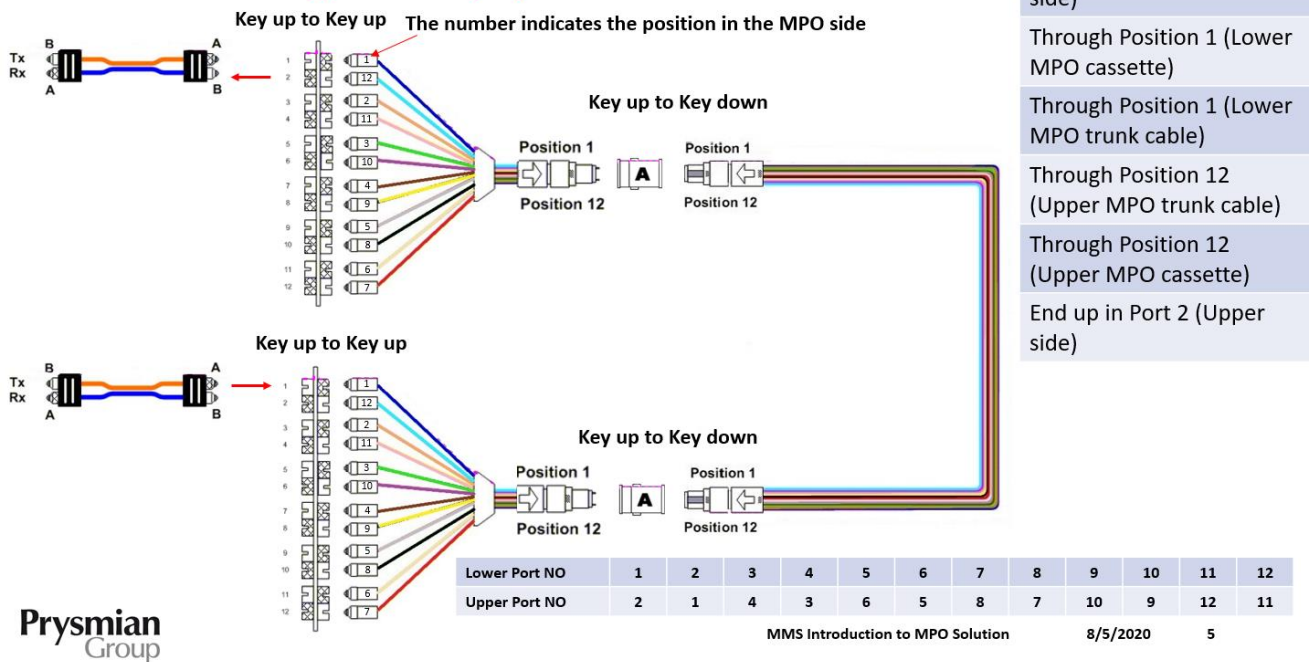

## 10G MPO Channel **Type P SM Key Down**

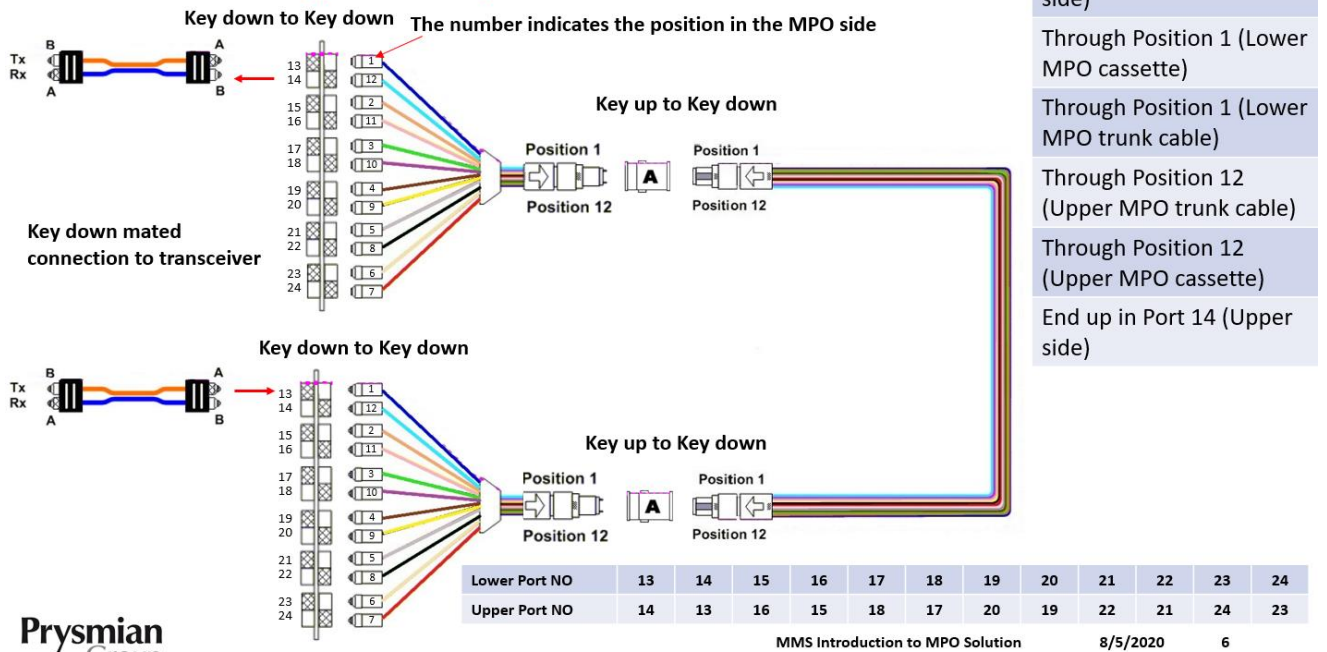











## Ordering Information

| UC Part Number   | SAP1C      | Description   | Weight (g) | Packaging   |
|------------------|------------|---|------------|-------------|
|                  |            | <b>Type "P"</b>   |            |             |
| PPMSPM19541D-P12 | YMMBP02826 | DRAKA UCONNECT UC9500 SERIES 1xMPO/APC-12(M)-LC/UPC(D) MODULE SM G.657A2 TYPE P BLUE                          | 126        | 1 set / box |
| PPMLPM19541D-P12 | YMMBP03134 | DRAKA UCONNECT UC9500 SERIES LOW LOSS 1xMPO/APC-12(M)-LC/UPC(D) MODULE SM G.657A2 TYPE P BLUE                 | 126        | 1 set / box |
| PPMSPM29542D-P24 | YMMBP03342 | DRAKA UCONNECT UC9500 SERIES 2xMPO/APC-12(M)-LC/UPC(D) MODULE SM G.657A2 TYPE P BLUE                          | 140        | 1 set / box |
| PPMLPM29542D-P24 | YMMBP02829 | DRAKA UCONNECT UC9500 SERIES LOW LOSS 2xMPO/APC-12(M)-LC/UPC(D) MODULE SM G.657A2 TYPE P BLUE                 | 140        | 1 set / box |
| PPMSPM29546D-P24 | TBC        | DRAKA UCONNECT UC9500 SERIES 2xMPO/APC-12(M)-LC/UPC(D) MODULE SM G.657A2 KEY UP AND DOWN TYPE P BLUE          | 140        | 1 set / box |
| PPMLPM29546D-P24 | TBC        | DRAKA UCONNECT UC9500 SERIES LOW LOSS 2xMPO/APC-12(M)-LC/UPC(D) MODULE SM G.657A2 KEY UP AND DOWN TYPE P BLUE | 140        | 1 set / box |
| PPMSPM19551D-P12 | TBC        | DRAKA UCONNECT  | 126        | 1 set / box |

|                  |     |   |     |             |
|------------------|-----|---|-----|-------------|
|                  |     | UC9500 SERIES 1xMPO/UPC-12(M)-LC/UPC(D) MODULE MM OM4 TYPE P VIOLET   |     |             |
| PPMLPM19551D-P12 | TBC | DRAKA UCCONNECT<br>UC9500 SERIES LOW LOSS 1xMPO/UPC-12(M)-LC/UPC(D) MODULE MM OM4 TYPE P VIOLET                 | 126 | 1 set / box |
| PPMSPM29552D-P24 | TBC | DRAKA UCCONNECT<br>UC9500 SERIES 2xMPO/UPC-12(M)-LC/UPC(D) MODULE MM OM4 TYPE P VIOLET                          | 140 | 1 set / box |
| PPMLPM29552D-P24 | TBC | DRAKA UCCONNECT<br>UC9500 SERIES LOW LOSS 2xMPO/UPC-12(M)-LC/UPC(D) MODULE MM OM4 TYPE P VIOLET                 | 140 | 1 set / box |
| PPMSPM29556D-P24 | TBC | DRAKA UCCONNECT<br>UC9500 SERIES 2xMPO/UPC-12(M)-LC/UPC(D) MODULE MM OM4 KEY UP AND DOWN TYPE P VIOLET          | 140 | 1 set / box |
| PPMLPM29556D-P24 | TBC | DRAKA UCCONNECT<br>UC9500 SERIES LOW LOSS 2xMPO/UPC-12(M)-LC/UPC(D) MODULE MM OM4 KEY UP AND DOWN TYPE P VIOLET | 140 | 1 set / box |
| PPMSPM19561D-P12 | TBC | DRAKA UCCONNECT<br>UC9500 SERIES 1xMPO/UPC-12(M)-LC/UPC(D) MODULE MM OM3 TYPE P AQUA                            | 126 | 1 set / box |
| PPMLPM19561D-P12 | TBC | DRAKA UCCONNECT<br>UC9500 SERIES LOW LOSS 1xMPO/UPC-12(M)-LC/UPC(D) MODULE MM OM3 TYPE P AQUA                   | 126 | 1 set / box |
| PPMSPM29562D-P24 | TBC | DRAKA UCCONNECT<br>UC9500 SERIES 2xMPO/UPC-12(M)-LC/UPC(D) MODULE MM OM3 TYPE P AQUA                            | 140 | 1 set / box |
| PPMLPM29562D-P24 | TBC | DRAKA UCCONNECT<br>UC9500 SERIES LOW LOSS 2xMPO/UPC-12(M)-LC/UPC(D) MODULE MM OM3 TYPE P AQUA                   | 140 | 1 set / box |
| PPMSPM29566D-P24 | TBC | DRAKA UCCONNECT<br>UC9500 SERIES 2xMPO/UPC-12(M)-LC/UPC(D) MODULE MM OM3 KEY UP AND DOWN TYPE P AQUA            | 140 | 1 set / box |
| PPMLPM29566D-P24 | TBC | DRAKA UCCONNECT<br>UC9500 SERIES LOW LOSS 2x MPO/UPC-12(M)-LC/UPC(D) MODULE MM OM3 KEY UP AND DOWN TYPE P AQUA  | 140 | 1 set / box |

## Color Coding

| Item    |     | Color Coding   |  |   |  |   |
|---------|-----|--|--|---|--|---|
|         |     | SM   | SM/APC   | OM1 & OM2   | OM3  | OM4   |
| Adaptor | LC  | Blue<br>  | Green<br> | Beige<br> | Aqua<br>  | Violet<br> |
|         | MPO | Black<br> | Black<br> | Black<br> | Black<br> | Black<br>  |

## Enquiries

Please contact our local sales office or email to: [mms.asia@prysmiangroup.com](mailto:mms.asia@prysmiangroup.com)

Multimedia Solutions is the data communication portfolio of Prysmian Group and comprises all the necessary portfolio of cable solutions for data communication.

Ask about UC CONNECT for a complete Structured Cabling Solutions with 25 Years System Warranty.

Visit [www.drakauc.com](http://www.drakauc.com) for more information.

© PRYSMIAN GROUP 2022, All Rights Reserved

All sizes and values without tolerances are reference values. Specifications are for product as supplied by Prysmian Group: any modification or alteration afterwards of product may give different result.

The information contained within this document must not be copied, reprinted or reproduced in any form, either wholly or in part, without the written consent of Prysmian Group. The information is believed to be correct at the time of issue. Prysmian Group reserves the right to amend this specification without prior notice. This specification is not contractually valid unless specifically authorised by Prysmian Group.