

## VERTICASA<sup>XS</sup>

Delivering fibre to every floor



## Linking the future

As the worldwide leader in the cable industry, Prysmian Group believes in the effective, efficient and sustainable supply of energy and information as a primary driver in the development of communities.

With this in mind, we provide major global organisations in many industries with best-in-class cable solutions, based on state-of-the-art technology. Through two renowned commercial brands – Prysmian and Draka – based in almost 100 countries, we’re constantly close to our customers, enabling them to further develop the world’s energy and telecoms infrastructures, and achieve sustainable, profitable growth.

In our energy business, we design, produce, distribute and install cables and systems for the transmission and distribution of power at low, medium, high and extra-high voltage.

In telecoms, the Group is a leading manufacturer of all types of copper and fibre cables, systems and accessories – covering voice, video and data transmission.

Drawing on over 130 years’ experience and continuously investing in R&D, we apply excellence, understanding and integrity to everything we do, meeting and exceeding the precise needs of our customers across all continents, at the same time shaping the evolution of our industry.

## Introducing *xsNET*

From aerial and underground installations, through to both simple and more complex residential networks, Prysmian’s *xsNET* family of products and solutions represents a new standard in Fibre To The Home (FTTH). Answering the critical need for ease of deployment, flexibility, reliability and cost-efficiency – and being backed by a full suite of valuable support services – *xsNET* is the ideal range of cabling for today’s changing world.



Value Innovation for your Broadband Network

*xsNET*  
**INDOOR SOLUTIONS**

*xsNET*  
**POP SOLUTIONS**

*xsNET*  
**OSP SOLUTIONS**

*xsNET*  
**ENGINEERING SOLUTIONS**

**QUICKDRAW<sup>XS</sup>**

**SIROCCO<sup>XS</sup>**

**OASYS**

**JETNET<sup>XS</sup>**

**RETRACTANET<sup>XS</sup>**

**VERTICASA<sup>XS</sup>**

**VERTV<sup>XS</sup>**

**EASENET<sup>XS</sup>**

**BENDBRIGHT<sup>XS</sup>**

Supported throughout by *BENDBRIGHT<sup>XS</sup>* fibre technology



# VERTICASA<sup>XS</sup>

## Cutting the cost of MDU network installation

Designed specifically for bringing optical fibre directly to residents of high-rise apartments and offices, the heart of the VERTICASA<sup>XS</sup> system features a new concept in optical cable construction allowing remarkably easy fibre access and break-out, reducing the demand for skilled labour and installation time and cost.

The VERTICASA<sup>XS</sup> system provides a fast and flexible means of connecting users in a Multi Dwelling Unit (MDU). The system comprises a main riser cable of up to 96 fibres, which can be branched directly to individual subscribers on different floors of the MDU without the need for the splicing of fibre within the riser of the building.

Fibres are extracted from breakout windows cut into the main cable which allows the required length of protected 'easy strip' fibre to be routed directly from the main body of the cable through to the end user. A pre-connectorised drop cable may be used to provide the final customer connection.

The VERTICASA<sup>XS</sup> system comprises all supporting accessories and connectivity products necessary to complete the full installation from main fibre distribution point, generally in the basement of the MDU, through to the end user.

## Where is fibre going?

The increasing number of services available via optical fibre (Broadband Internet, VoIP, Video on Demand, High Definition IPTV) and the need to provide higher bandwidth capability – both upstream and downstream – is leading network operators to replace copper wire networks with optical fibre deeper into the last mile and closer to the customer.

Consequently it is important to keep down installation and operational costs in structures like high-rise buildings and MDUs and minimise the impact of the work on the final customer.

# Features & Benefits

- Innovative cable system
- Extractable Easy Strip Fibre Units (ESFU) are protected by a Low Smoke Zero Halogen (LSOH) covering
- A range of supporting connectivity products for cable breakout, splicing and customer termination
- Latest bend insensitive fibre technology supplied in *VERTICASA<sup>XS</sup>* cables
- Re-enterable system
- Reduced fusion splicing time, cost and power loss
- No need for skilled labour
- Accepts the most common mechanical splices and field mountable connectors

The latest optical fibre technology applied to a new optical cable and connectivity products allows easy installation of the *VERTICASA<sup>XS</sup>* system in different scenarios: mid-size buildings (typically buildings of 10 floors), high-rise buildings (10 floors or more), low-rise/high occupancy buildings, offices/open spaces.

## **BENDBRIGHT<sup>XS</sup>**

The *VERTICASA<sup>XS</sup>* system is available with *BENDBRIGHT<sup>XS</sup>* fibre, the ITU-T G657.A2/B2 compliant optical fibre optimised for excellent bend performance.



## Fibre Access Breakout

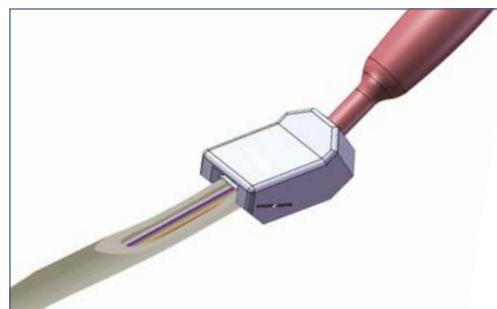

1. The *VERTICASA<sup>XS</sup>* stripping tool safely cuts a breakout window in the riser cable, providing access to the fibres.

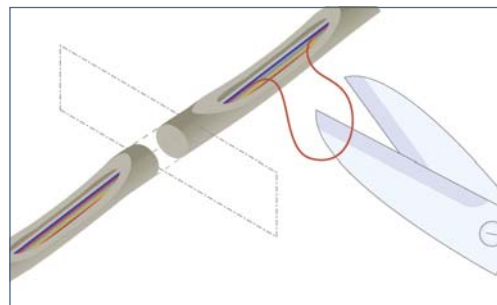

2. The selected fibre unit (ESFU) can be extracted and cut. This operation is performed some floors above the floor where the customer is to be connected.

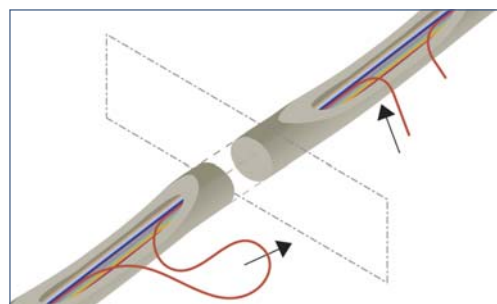

3. At the floor where the fibre connection is requested, the ESFU that was cut on the higher floor can now be easily extracted.



## Product List

### Cable System



#### **VERTICASA<sup>XS</sup> Riser Cable**

A patented cable system of up to 96 fibres which can be branched directly to individual subscribers on different floors of the MDU.



#### **VERTICASA<sup>XS</sup> Drop Tube**

Routes the extracted fibre directly to the end user.



#### **VERTICASA<sup>XS</sup> Drop Cable**

Ruggedised 1 or 2 fibre G657 drop cable.



#### **VERTICASA<sup>XS</sup> Stripping Tool**

A special tool to cut a breakout window in the cable allowing easy fibre access.

### Riser Box



#### **VERTICASA<sup>XS</sup> Riser Box**

Allows the VERTICASA<sup>XS</sup> cable to be spliced to up to 12 customer drop cables.



#### **VERTICASA<sup>XS</sup> Internal Transition Box**

Enables the splicing of up to 4 drop cables to a main in-line cable.

### Accessories



#### **VERTICASA<sup>XS</sup> 1 port and 4 port Breakout Units**

Distributes the fibres from an in-line VERTICASA<sup>XS</sup> cable into drop tubes.



#### **VERTICASA<sup>XS</sup> Cable Protection Cover**

Covers the breakout section of the cable.



#### **VERTICASA<sup>XS</sup> Mechanical Splice Holder**

Accommodates up to 2 mechanical splices.

### Customer Termination



#### **Compact Termination Box**

Designed for the termination of up to 4 fibres.



#### **Ultra Compact Termination Box**

Designed for the termination of up to 2 fibres.



#### **VERTICASA<sup>XS</sup> Multi-Operator MDU Demarcation Box**

Connects the vertical in-building cable with the input fibres from one or more operators.

# Mid-sized Buildings

## Typically up to 10 floors

The *VERTICASA<sup>XS</sup>* system can be installed in mid-sized buildings in order to bring optical fibre to individual subscribers on different floors. The system is equally applicable to existing and new-build constructions and is environmentally friendly in terms of both its minimal size and neutral colour scheme.

A complete range of connectivity products provides full compatibility for various scenarios:

### 1. Zero splice

The ESFU extracted from the riser cable via the 4 port breakout unit can be routed directly to the customer termination through the drop tube, without the need for any splice.

### 2. Preconnectorised drop cable

To cover longer distances on the floor, a mechanical splice holder can accommodate up to 2 mechanical splices allowing the outgoing drop cable to reach the customer termination box.

### 3. High subscription rate per floor

The riser box and the internal transition box enable the splicing of the customer drop cables to the main *VERTICASA<sup>XS</sup>* riser cable providing the flexibility to serve a larger number of final customers.



Floor 10

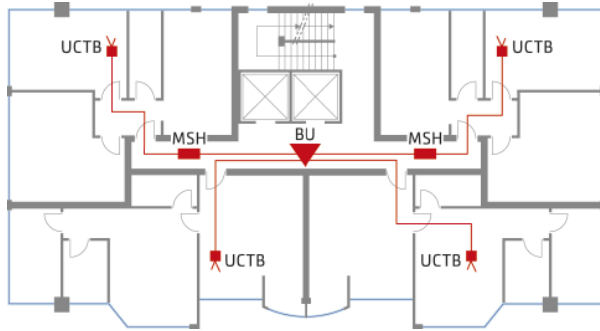

Floor 5

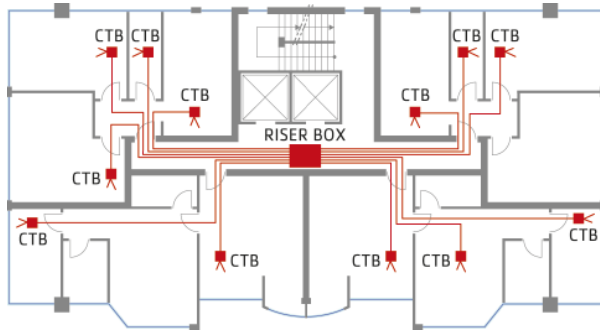

Floor 1

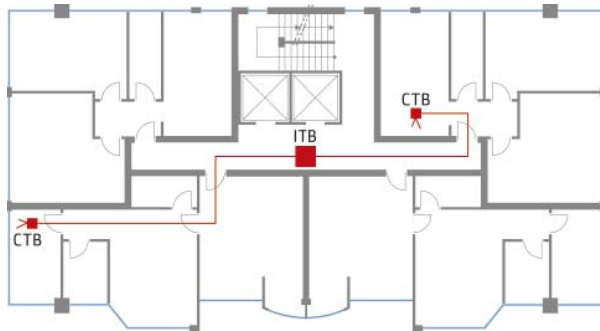

Floor -1

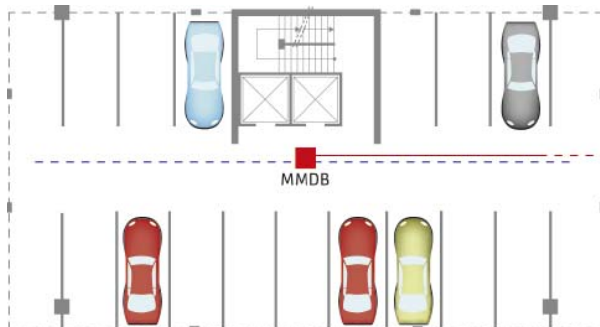

# High-rise Buildings

## More than 10 floors

The installation methodology for *VERTICASA<sup>XS</sup>* utilised in mid-sized buildings can be extended in a modular fashion in order to address the requirements of high-rise buildings. Cable installation and fibre breakout is carried out for the first 10 floors in exactly the same way as for a mid-sized building. For the next 10 floors a second cable is run from the basement up the riser, as far as level 20.

The first 10 floors are by-passed by this cable and a loop is made in the cable at floor 10. Customers are then connected on floors 11 to 20 in the same manner as with the first cable.

The process is repeated with floors 21-30 being served by a third cable with a loop introduced at floor 20. Subsequent levels are served by further repeating this process. The looping process prevents any gravitational forces being applied to the ESFU when it is cut prior to being removed from the breakout window.





Floors 10 - 20 - 30

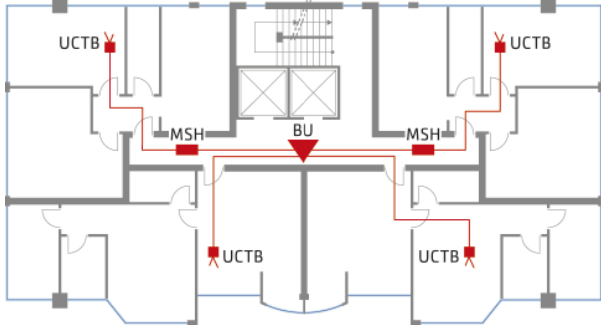

Floors 5 - 15 - 25

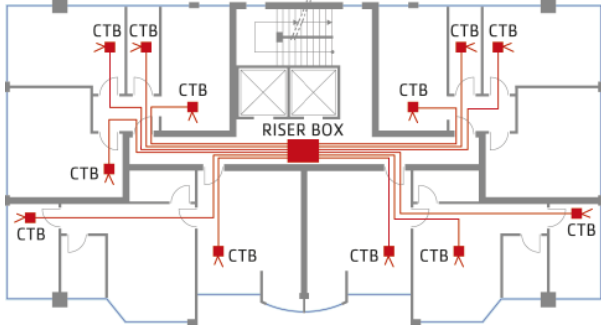

Floors 1 - 11 - 21

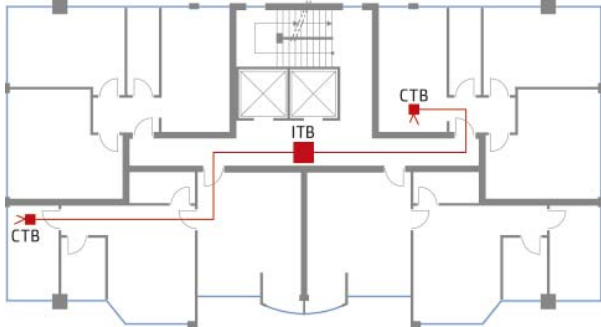

Floor -1

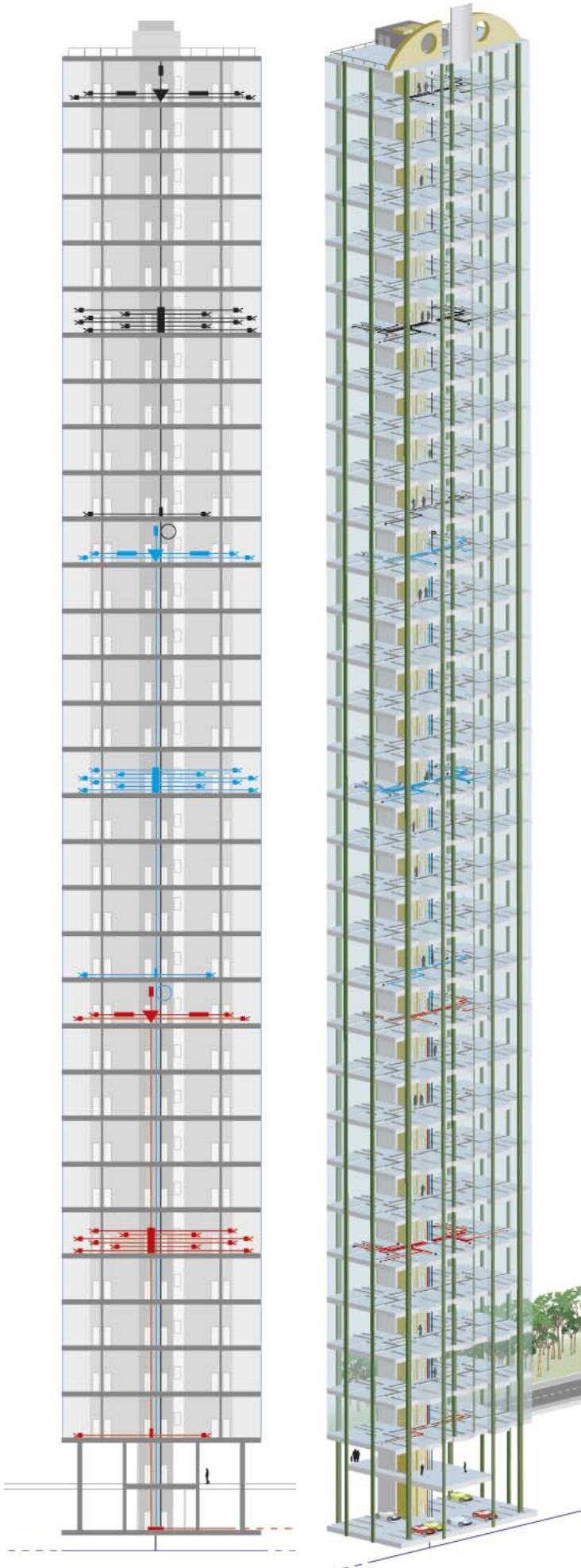
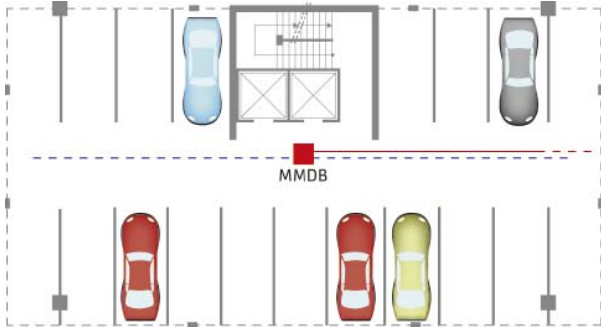

# Low-rise Buildings

## Hotels, Resorts, Schools and Hospitals

The *VERTICASA<sup>XS</sup>* system can also be used in low-rise constructions of just a few floors. A single cable can serve multiple end users on a single floor thanks to the adaptability of the supporting accessories and connectivity products.

The *VERTICASA<sup>XS</sup>* cable, due to its small diameter, can be installed in existing ducting together with other utility cables. Further applications may include any network where cascaded connections are needed e.g. video surveillance in subway systems through to providing broadband connections in the cabins of luxury cruise liners.



Floor 1

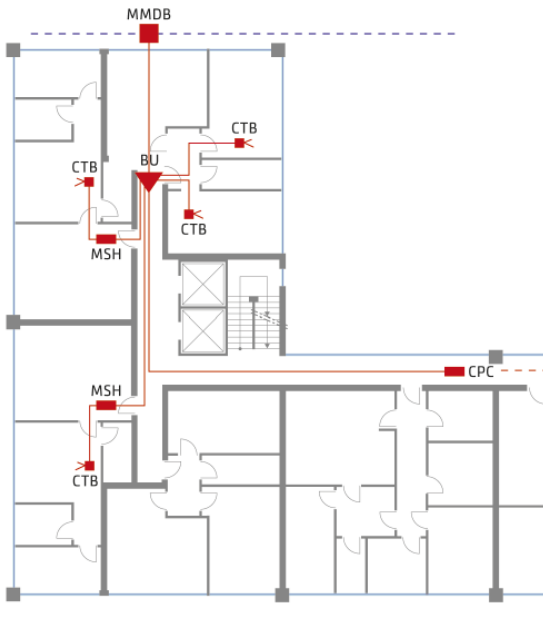

Floor 2

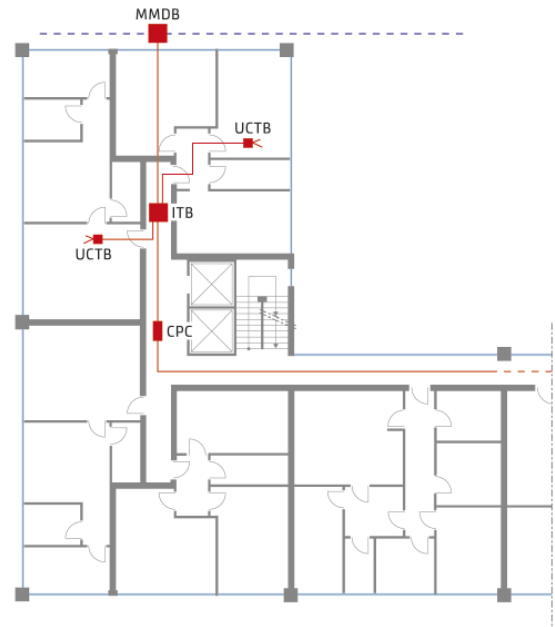

Floor 3

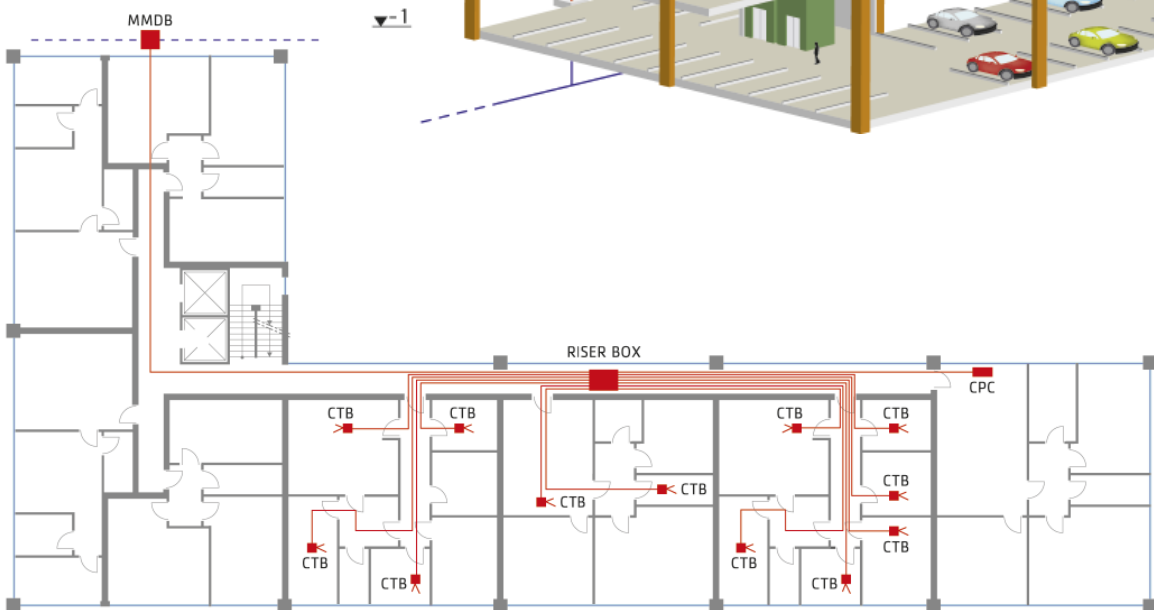

# Business

## Offices, Work Areas, Shopping Malls and Airports

In open spaces such as office environments, the *VERTICASA<sup>XS</sup>* riser cable can be routed around the perimeter wall or under the floating floor providing connections as and where needed. Internal transition boxes can splice up to 4 drop cables to a main cable. This can be extended to 12 by use of a riser box. The compact termination box can be used to terminate fibres for both business or residential applications. The overall system is therefore highly flexible and can accommodate changes such as adding extra workstations or even modifying the architecture within the workspace.



Work Area

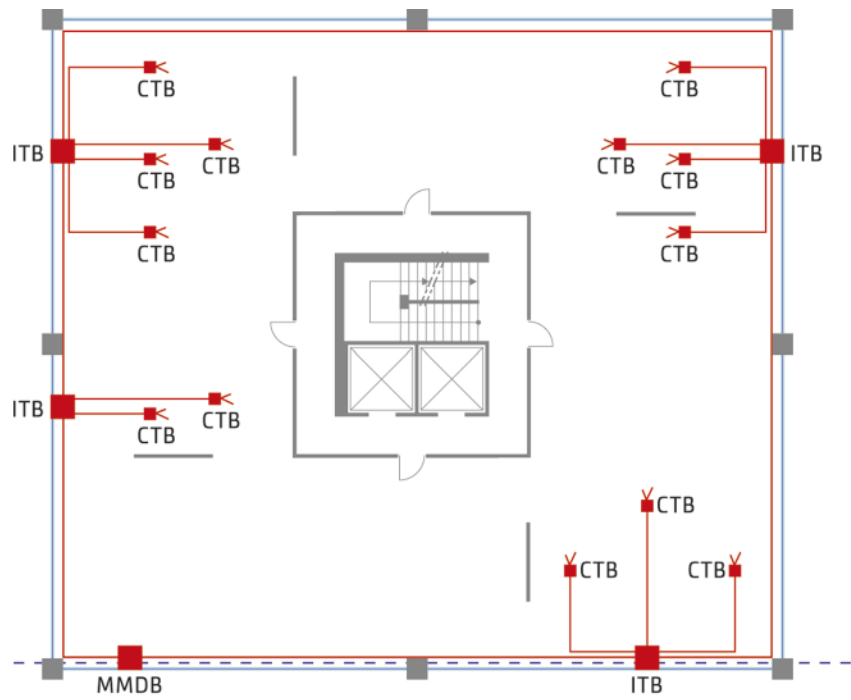

# External Applications

## External Risers, Old Buildings and Rurals

The *VERTICASA<sup>XS</sup>* system is also suitable for external installation. A range of external cables and accessories has been developed to resist the most severe environmental and weather conditions. This new design maintains the main characteristics of the *VERTICASA<sup>XS</sup>* system, namely the ease, speed and flexibility of installation. Also in this case a fibre module length can be extracted from the riser cable and directly routed to a termination (or distribution) box through an external drop tube.

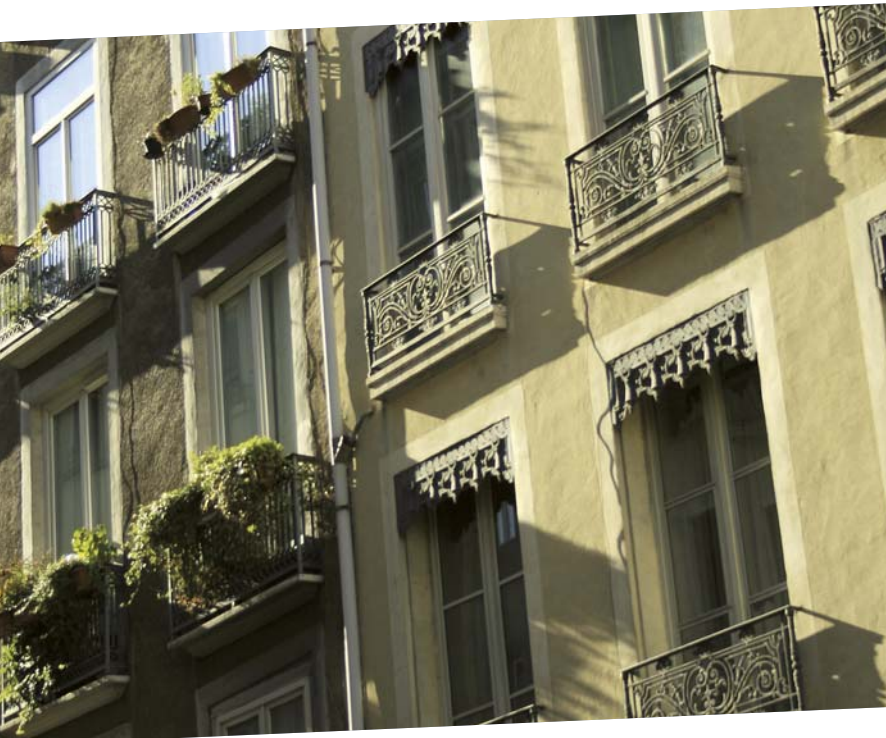

Typical installation layout



# Cable Systems

## Key Features

The heart of the *VERTICASA*<sup>XS</sup> system is the breakthrough cable solution which has been developed specifically for this application. Cables are based upon the principle of the Extractable Easy Strip Fibre Unit (ESFU) in which the fibre is protected by a semi-tight polymer jacket which provides mechanical protection whilst being easily strippable, by hand, up to a length of approximately 1 metre in a few seconds. The main user cable can contain up to 48 ESFUs, each of which may contain 1 or 2 optical fibres. Fibres are then routed from the riser cable, through a breakout window, when a customer connection is required to be made.





### VERTICASA<sup>XS</sup> Riser Cable

The cable consists of 12, 24, 48 or 96 bend insensitive G657.A2/B2 optical fibres protected with easy-strip buffer compound. The fibre units are protected by a flame retardant Afumex (LSOH) outer sheath. During the sheathing process, two Glass Reinforced Plastic (GRP) rods are included. The cable is also available with a UV resistant sheath for external installation.

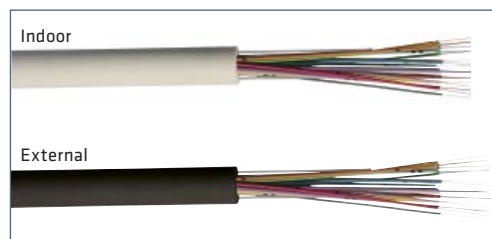

### VERTICASA<sup>XS</sup> Drop Cable

The cable consists of one or two bend insensitive G657.A2/B2 optical fibres. The ESFU is surrounded by aramid longitudinal strength members, and protected by a flame retardant Afumex (LSOH) sheath.



### VERTICASA<sup>XS</sup> Drop Tube

Takes the extracted fibre directly to the end user. The tube, made from flame retardant Afumex (LSOH) compound, contains a suitable yarn or cord rope to pull the ESFU (Easy Strip Fibre Unit) through the tube.

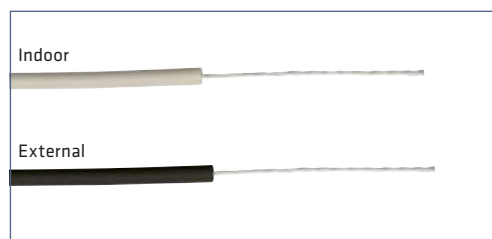

### Ruggedised Drop Cable

To extend the reach of the drop fibre or for further protection when the installation is performed with a traditional telephone copper cable stapling gun, a ruggedised design prevents any fibre damage.



### VERTICASA<sup>XS</sup> Stripping Tool

The VERTICASA<sup>XS</sup> stripping tool safely cuts a window in the riser cable providing easy fibre access. The blade location and position in this special design avoids any risk of damage to the ESFUs.



# Riser Boxes

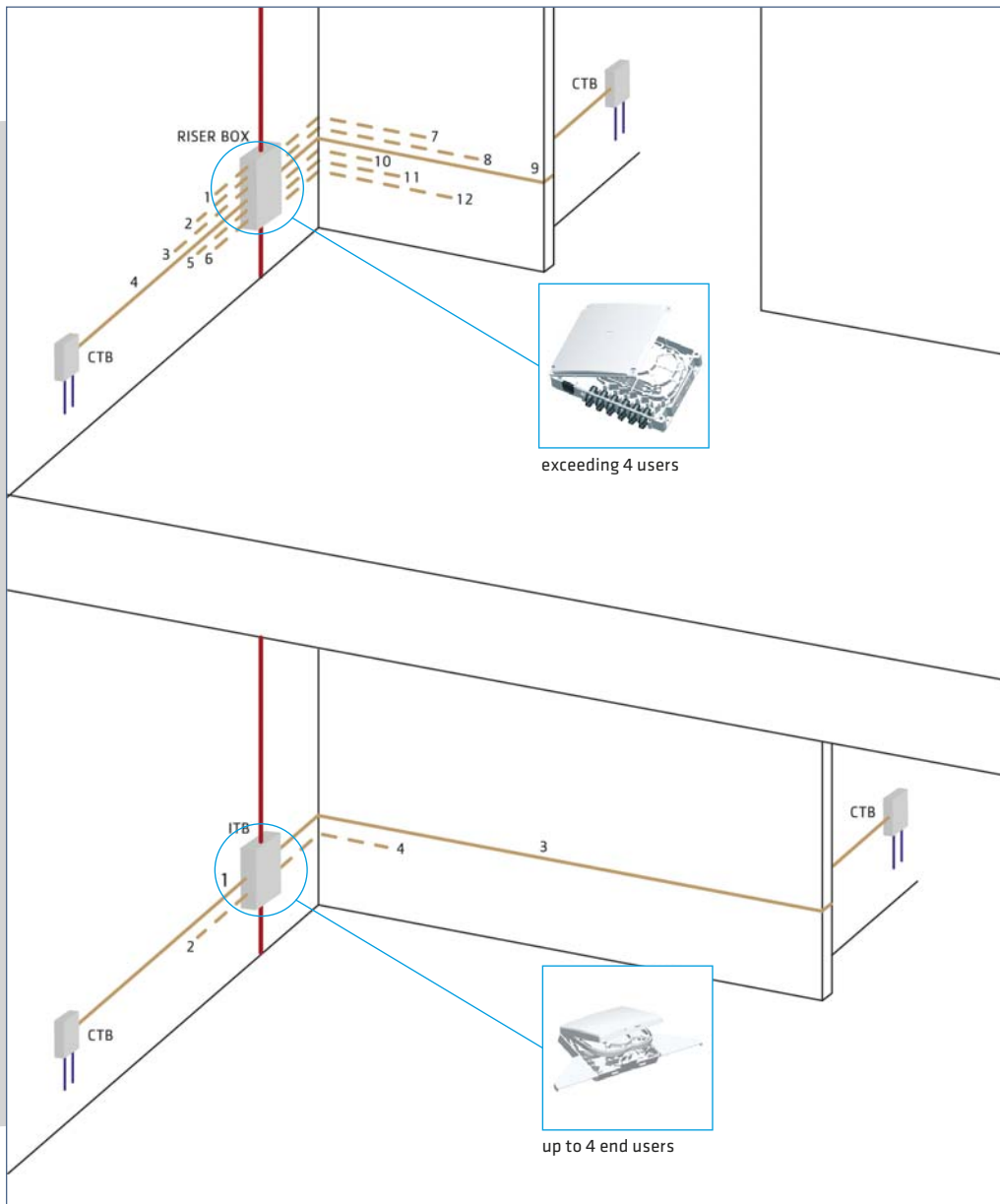



### **VERTICASA<sup>XS</sup> Riser Box**

The riser box is designed for use within apartment blocks and mid-sized and high-rise office blocks. The unit houses a single integral splice tray, and allows fibres from a VERTICASA<sup>XS</sup> riser cable to be spliced to up to 12 customer drop cables.

A tailored accessory provides the space to loop ESFUs that are extracted from the VERTICASA<sup>XS</sup> riser cable on day one and routed to the home at a later date.

The compact wall mounted unit allows installation within small spaces in residential and business premises alike.

It features a removable cover for easy access and rubber grommets to secure the drop cables.



### **VERTICASA<sup>XS</sup> Internal Transition Box**

The VERTICASA<sup>XS</sup> Internal Transition Box (ITB) is mainly used for MDUs or office fibre cabling systems. It is a compact splicing box enabling the splicing of up to 4 drop cables to a VERTICASA<sup>XS</sup> cable. The ITB houses a single splicing tray to secure both mechanical or fusion splices installed in accordance with ITU Recommendation G652.

# Accessories

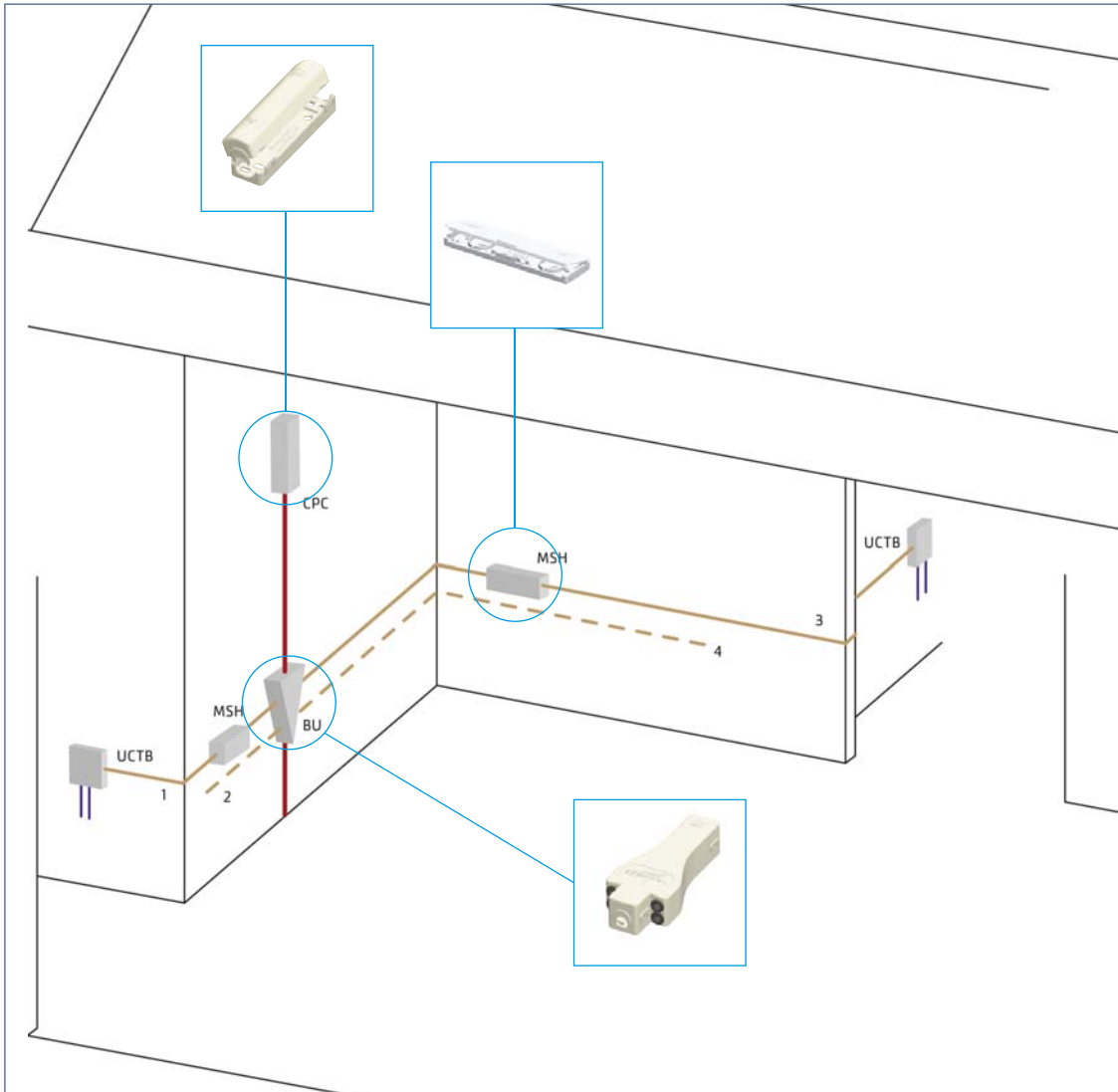

### **VERTICASA<sup>XS</sup> 1 port or 4 port Breakout Units**

The VERTICASA<sup>XS</sup> breakout units are typically used in MDUs to break out and distribute the fibres from an in-line VERTICASA<sup>XS</sup> riser cable into drop tubes, for routing to a customer premise. They have the capacity to accommodate the full range of VERTICASA<sup>XS</sup> cables.

Protected by the breakout unit will be a window, cut into the cable, to access the fibres which can be spurred off into drop tubes. The smaller unit accommodates a single tube drop off, to the left or right side of the riser cable. The 4 port breakout unit allows up to 4 drops, two on either side for use on day 1 or added to later.



BU

### **VERTICASA<sup>XS</sup> Mechanical Splice Holder**

The VERTICASA<sup>XS</sup> Mechanical Splice Holder (MSH) is mainly used for MDUs or office fibre cabling systems. The unit is suitable for splicing together up to 2 incoming fibres from the riser cable to 2 outgoing fibres to apartment/s. The MSH will accommodate the required 1 or 2 mechanical splices. It can be easily installed and fitted to the wall or inside a riser and accommodates cables of up to 6mm in diameter.



MSH

### **VERTICASA<sup>XS</sup> Cable Protection Cover**

The VERTICASA<sup>XS</sup> cable protection cover is typically used in MDUs or office fibre cabling systems. It is used to cover and protect the window cut in a VERTICASA<sup>XS</sup> cable.

It has the capacity to accommodate the full range of VERTICASA<sup>XS</sup> cables and is supplied with all of the components required to mount the unit to a wall and secure an in-line VERTICASA<sup>XS</sup> cable.



CPC

### **VERTICASA<sup>XS</sup> Outdoor Breakout Unit**

The VERTICASA<sup>XS</sup> outdoor breakout unit has the same characteristics as the internal one, but presents some other additional features that make it suitable to the external environment. The box is gel-sealed, re-enterable and supplied with a special plate for wall fixing.

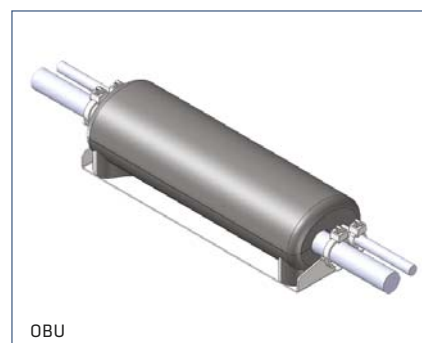

OBU

# Customer Terminations

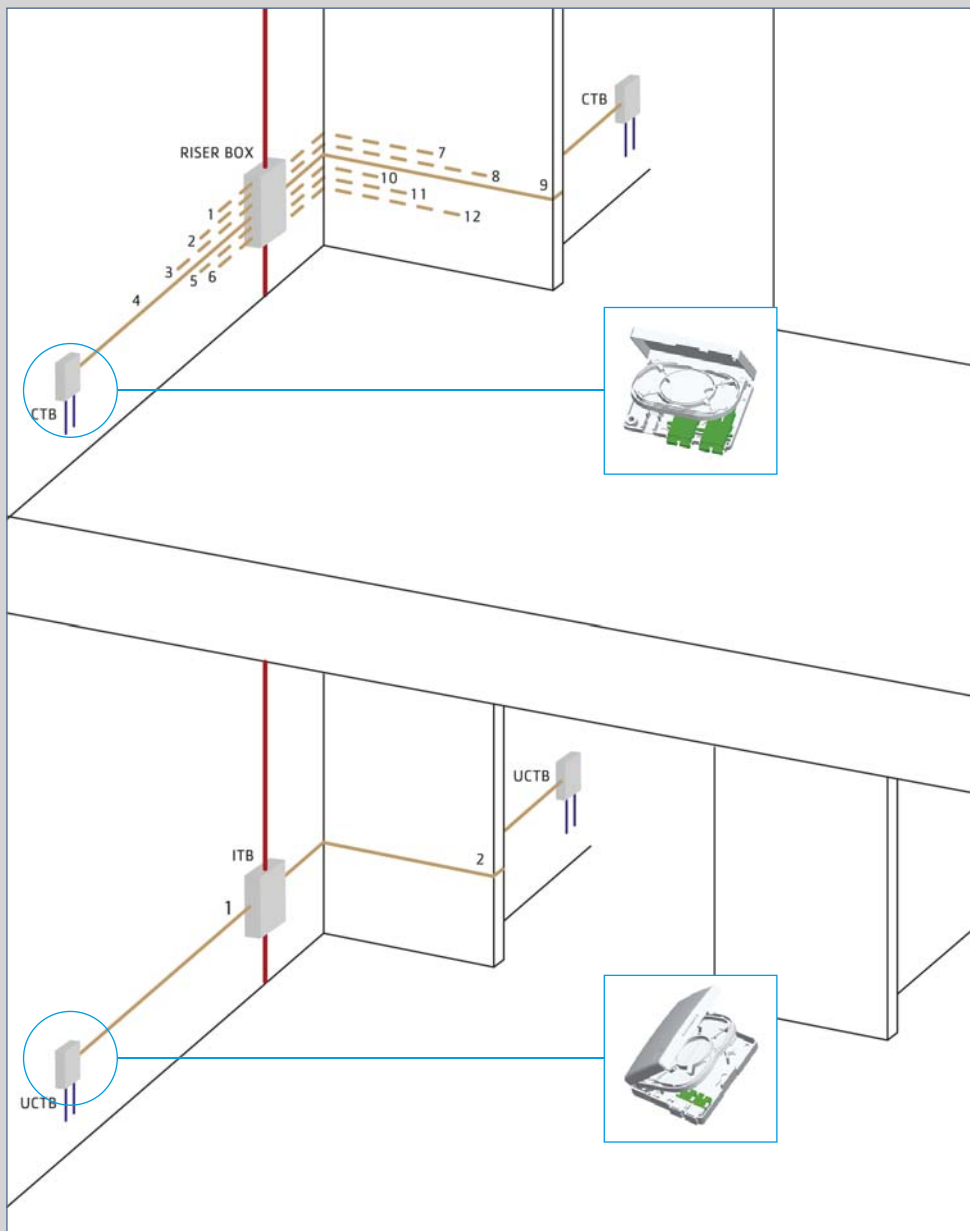

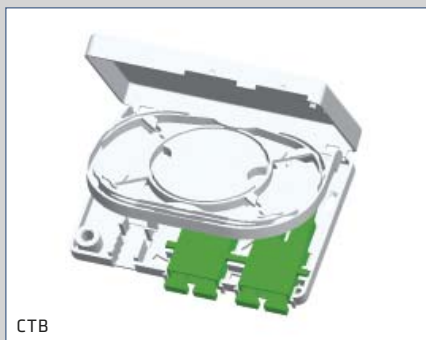

CTB

### **VERTICASA<sup>XS</sup> Compact Termination Box**

The VERTICASA<sup>XS</sup> compact termination box is designed for use in residential and business applications for the termination of up to four fibres.

The wall box enables up to two VERTICASA<sup>XS</sup> drop cables (or using VERTICASA<sup>XS</sup> drop tubes) to be spliced to up to four SC pigtails (PC or APC), which connect to adapters at the base of the unit.

The unit can be quickly installed within an office, house or communication room environment.



UCTB

### **VERTICASA<sup>XS</sup> Ultra Compact Termination Box**

The VERTICASA<sup>XS</sup> Ultra Compact Termination Box (UCTB) is designed for use in residential and business applications for the termination of up to two fibres. The wall box enables a VERTICASA<sup>XS</sup> drop cable (or using VERTICASA<sup>XS</sup> drop tube) to be spliced to one or two SC pigtails (PC or APC), which connect to shuttered adaptors at the base of the unit.

Its ergonomic design allows cables to enter from the rear, bottom or top of the unit (the mark 2 version also allows access from either side). The UCTB is a reduced size version of the CTB made possible by the use of BENDBRIGHT<sup>XS</sup> G657.A2/B2 fibre.



ECTB

### **VERTICASA<sup>XS</sup> External Compact Termination Box**

The external compact termination box is designed for use in residential, small and large business premises. The unit houses a single splice tray and allows fibres from external cables to be spliced to pigtails for connection to preconnectorised customer drop cables. The external cable enters from the bottom of the unit, with the customer drop cables (patch cords) exiting from the bottom of the unit or directly through the back of the box and through the wall. The ECT box is also available in a splice-only version to allow an incoming VERTICASA<sup>XS</sup> cable to be spliced to an external drop cable or patchcords.

# Multi-Operator MDU Demarcation Box

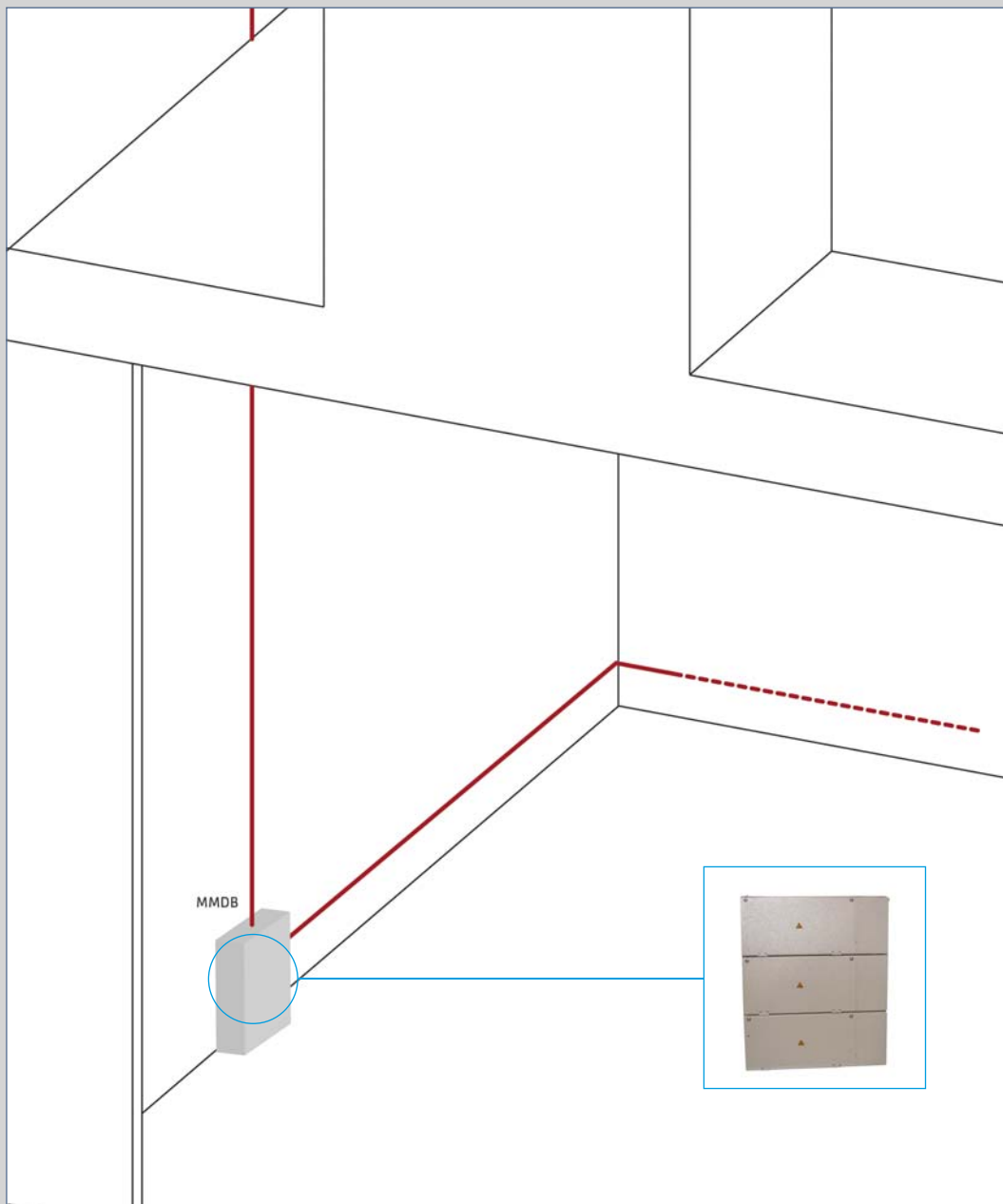



## VERTICASA<sup>XS</sup> Multi-Operator MDU Demarcation Box

The VERTICASA<sup>XS</sup> Multi-Operator MDU Demarcation Box (MMDB) has a modular design with two different module configurations: a customer module to terminate the vertical cable(s) feeding the premises and an operator module to terminate the external network cable(s).

The MMDB allows the connection of several operators on a common network inside buildings. The MMDB, which can be installed in the building basement, allows shared usage of the vertical backbone building cable (cable from building basement to the connection housing on the floors) and the management of the fibres from the networks of several operators. A building network may house multiple interconnected customer and operator modules depending on requirements.

### Features & Benefits

The customer module can be equipped with up to 48 splices and patching for SC/PC or SC/APC connectors.

- The operator module can be equipped with up to 48 ruggedised pigtails.
- The customer and operator modules are mechanically linked together creating a patching channel to route the fibres with ruggedised pigtails from one module to another.
- Depending on the building topology several customer modules can be added on top of each other.
- In the case of shared vertical backbone building cabling, two or more operators can use separated operator modules to connect to the same customer module.
- The operator module accepts loop cables for a daisy chain installation.
- A dedicated storage area is available inside the operator module for non connected pigtails.
- To limit the access to the modules, each module has two separate doors, one for the splicing area and one for the patching area, secured with an Allen key.
- Four single-element trays are available per module.
- All cables are safely secured inside each module.
- Within the modules, all fibres are positively managed to maintain a 30mm minimum bend radius.
- The customer module can accommodate a variety of different connector types.



MMDB - Customer Module



MMDB - Operator Module

# Bend Insensitive Fibres

## The **BENDBRIGHT<sup>XS</sup>** Solution

With Prysmian's own G657.A2/B2 compliant fibres being used within the **VERTICASA<sup>XS</sup>** system, maximum performance is ensured in the presence of the tight bends often encountered when making final customer connections.

The **BENDBRIGHT<sup>XS</sup>** fibres are Prysmian's answer to the Fibre To The Home requirements in terms of bending. The **BENDBRIGHT<sup>XS</sup>** brand covers all the possible needs which can be encountered when a fibre requires to be brought to the customer's optical termination. All of these fibres have optimal spliceability with G652 fibres thanks to their very similar chemical composition and to their best-in-class geometrical parameters. This makes them truly compatible both with other fibre types and with optical systems employed globally. They benefit from **COLORLOCK<sup>XS</sup>**, the latest generation of coatings, which additionally provides enhanced resistance to 'high power' effects which can result in coating burns and glass fusion in certain amplified systems under severe bend conditions.

## The fibre that bends like copper

- 100x bending improvement over SMF
- Meets ITU-T G657.A2/B2 bending standards
- Fully compliant with ITU-T G652.D
- Backwards compatible with SMF
- Deployed in over 30 countries worldwide
- Over 5 million kilometers supplied with tens of millions of splices and connectors
- At the heart of **xsNET**

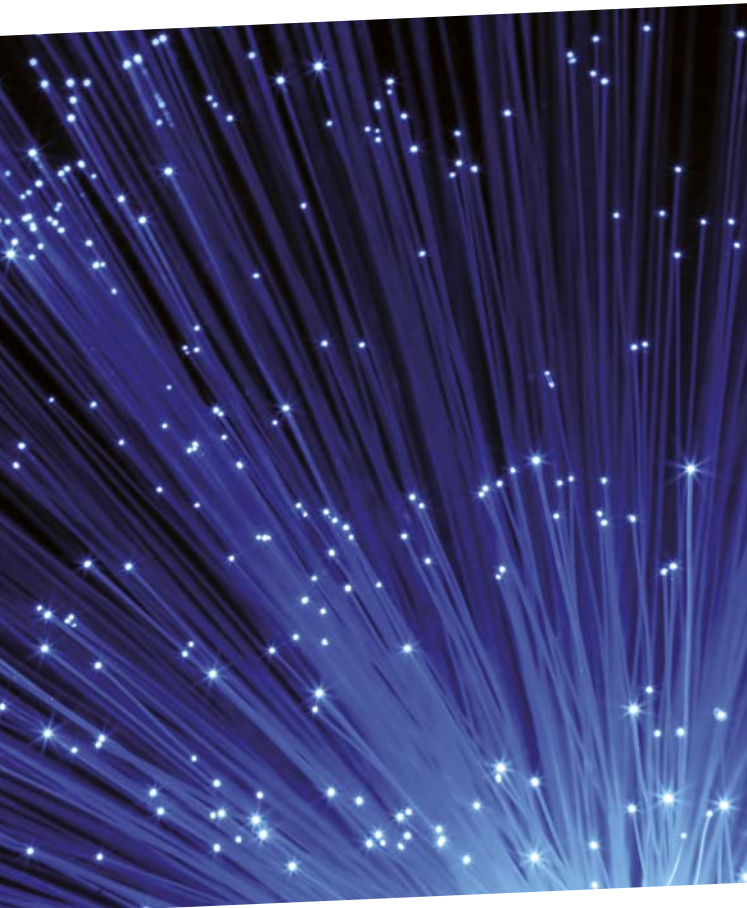

# One-stop-shopping with Prysmian's comprehensive integrated *xSNET* portfolio

Deploying a future-proof FTTx network is all about achieving the highest network reliability and customer satisfaction, whilst making the most of available resources and keeping costs low. Prysmian's fully integrated range of connectivity products provides all you need to build or adapt each segment of a low-maintenance FTTx network quickly and cost-effectively.

Our integrated *xSNET* range offers high grade optical fibre cables, carefully matched and easy-to-handle connectivity components and a choice of ducting solutions for indoor networks, outside plant networks and POP. And there's more: flexible design software and engineering advice based on three decades of broadband network design. With minimal effort, any network design, regardless of complexity or size, can be put together from scratch, updated or reconfigured.

## Prysmian Group's fibre optic and connectivity products

- Combined portfolio brings down the cost of FTTx
- Reach every community with an extensive portfolio of cable, connectivity and deployment technologies

## **xSNET**

Value Innovation for your Broadband Network

### Integrated *xSNET* concept

- Each standardised *xSNET* solution integrates seamlessly with the rest of the portfolio
- Each *xSNET* solution contains everything required to build a specific part of the network
- Operators can make service choices now, but also accommodate future upgrades and expansion
- Reduces the need for skilled labour
- Excellent logistical support
- Proprietary design software maps, configures, optimises and calculates costs of network concepts in seconds
- Changes and variations are easy to implement whilst designing and even after installation
- Expert engineering and consultancy services, plus professional support for building a winning business case

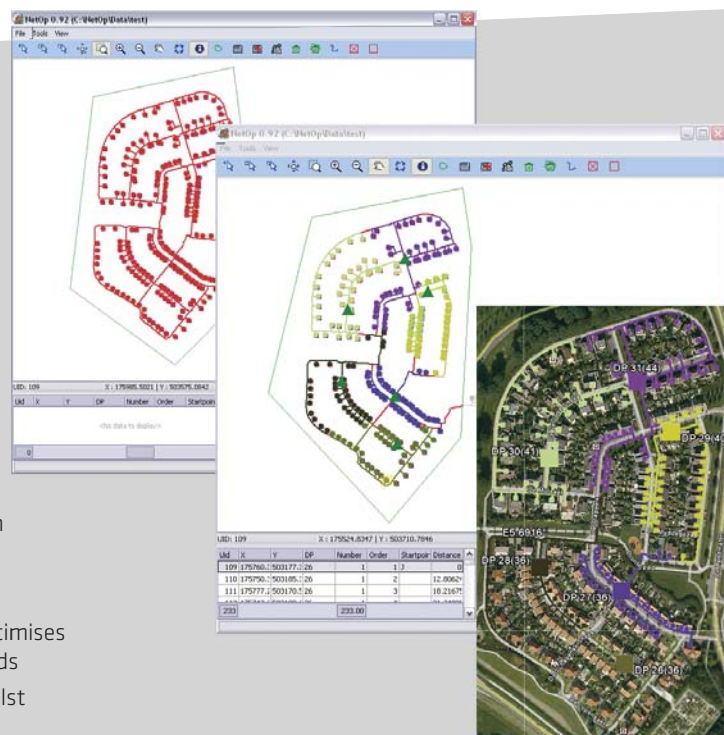

# Linking communications to communities

Prysmian Group, members of:



Prysmian Group  
Viale Sarca 222  
20126 Milan  
Italy

Email: [telecom@prysmiangroup.com](mailto:telecom@prysmiangroup.com)  
Tel: +39 02 6449 3500

[www.prysmiangroup.com](http://www.prysmiangroup.com)



**Prysmian**  
Group

